

## B803 Lighted Bollard



### Description

- Lumileds 2835 LED chips
- Corrosion resistant aluminum exterior
- Wattage & CCT adjustable
- 2 Shape options: round/square
- Flat Top & Dome option
- Cone or Louver reflector option
- Housing color: Brown/Black
- IP65 rated against dust and water
- 0-10V dimming

### Specification

#### Housing

Made from cast aluminum to withstand harsh weather.

#### Hardware

All exposed hardware is made of durable stainless steel, with industrial strength seals.

#### Interior Design & Optical

Energy efficient LED driver is mounted on a removable plate, with quick disconnect wiring to allow easy driver maintenance (Applicable for LED strip)

#### Exterior Design & Finish

Bollard is suitable for wet locations.



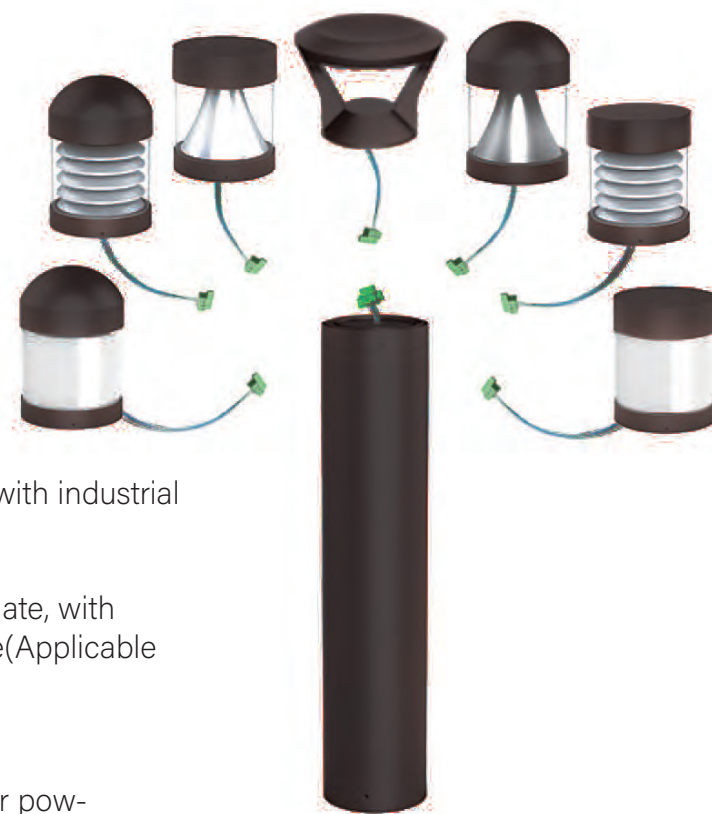

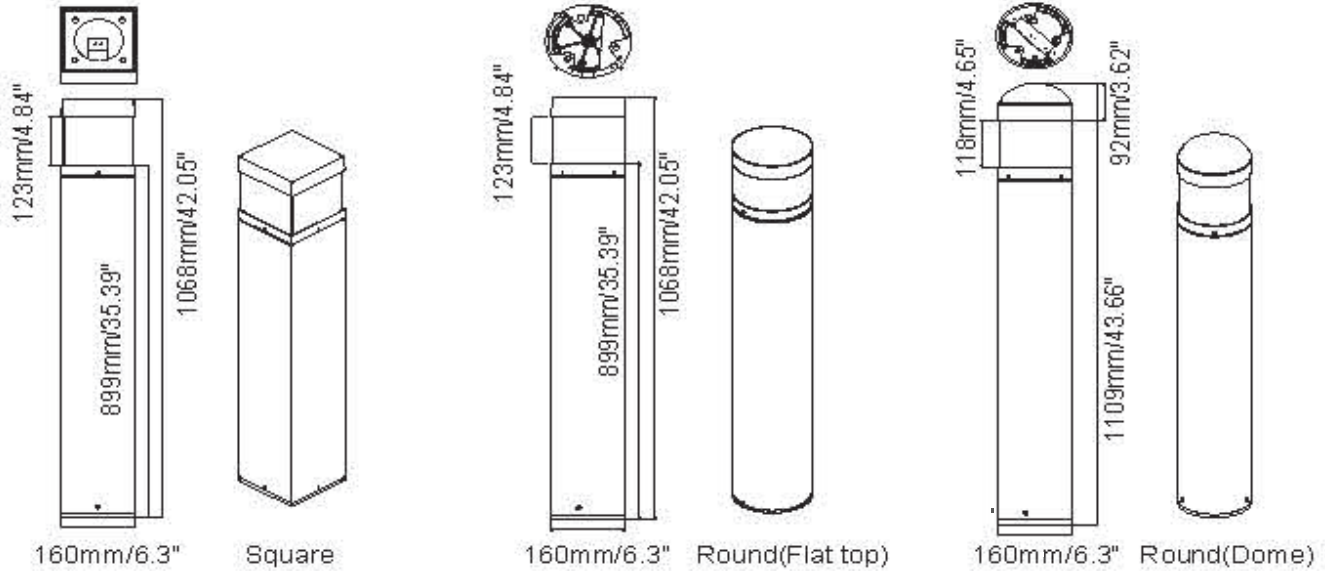

Finish is electrostatically applied with thermoset polyester powder-coat.



## Dimensions



## Product Ordering Number

PRODUCT	LUMENS	CCT	VOLTAGE	Head OPTIONS
B803	2860 Lumens	3000K 4000K 5000K  =10% Variance	120V-277V	 B1  B2  B3  B4  B5  B6  B7

### DIFFUSER TYPE

**CAC** Clear acrylic  
**WAC** White acrylic

### Color

Standard RAL  
6005 Green  
7012 Grey  
8019 Bronze  
9011 Black/Txt  
9016 White  
Custom RAL

